

CITY-MULTI®
CONTROLLERS



Remote Controller



System Controller

Mitsubishi Electric's Air-conditioner Network System (MELANS) leads air-conditioner management in a PC browser and network era.

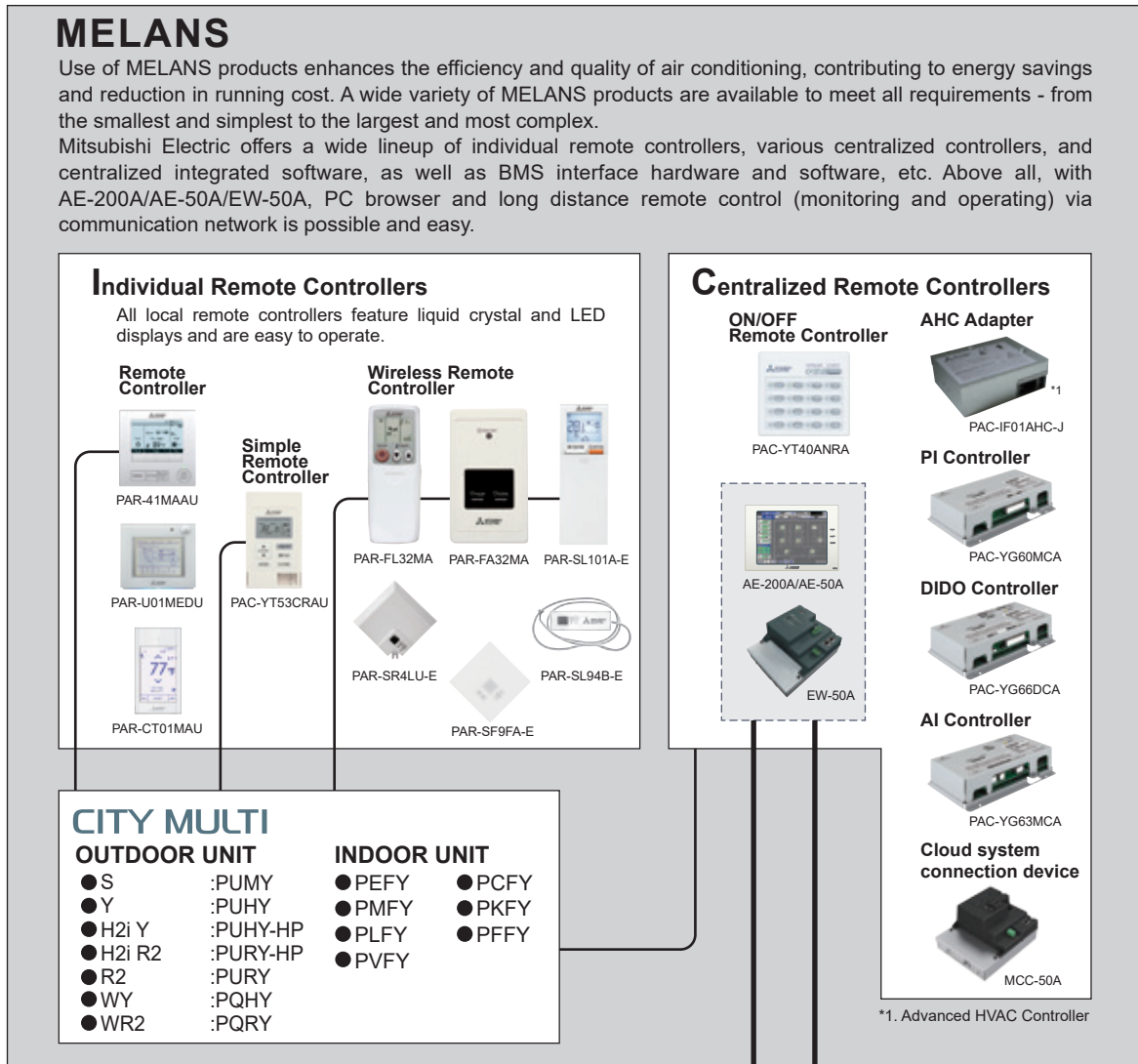

Interface
BACnet® transmission line (Ethernet)

Mitsubishi Electric's CITY MULTI can be easily connected to a building management system via BACnet®.

BUILDING MANAGEMENT SYSTEM

Ethernet

*Some controllers cannot be used in combination with certain models of devices.

Integrated Communications Control with Mitsubishi's Unique Transmission Network (M-NET)

Model	Local remote controller *5					
	PAR-CT01MAU	PAR-41MAAU	PAR-U01MEDU	PAC-YT53CRAU	PAR-FL32MA	PAR-SL101A-E
Controllable Groups/Indoors (Group/Indoor) *4	1/16	1/16	1/16	1/16	1/16	1 / 1
■Operation						
ON/OFF	○	○	○	○	○	○
Mode (cool/heat/dry/fan/auto)	○	○	○	○	○	○
Mode (Setback) *6	○	○	○	○	N	○
Temperature setting	○	○	○	○	○	○
Dual set point *7	○	○	○	○	N	○ *8
Local Permit/Prohibit	N	N	N	N	N	N
Fan speed	○	○	○	○	○	○
Air flow direction	○	○	○	○	○	○
■Status monitoring						
ON/OFF	○	○	○	○	○	○
Mode (cool/heat/dry/fan)	○	○	○	○	○	○
Temperature setting	○	○	○	○	○	○
Local Permit/Prohibit	○	○	○	○	N	N
Fan speed	○	○	○	○	○	○
Air flow direction	○	○	○	○	○	○
Indoor temperature	○	○	○	○	N	N
Filter sign	○	○	○	N	N	N
Error flashing	○	○	○	○	N	N
Error code	○	○	○	○	N	N
Operation hour	N	N	N	N	N	N
■Scheduling						
One day	○	○	○	N	N	N
ON/OFF times per day	1	1	1	N	1	1
Weekly	○	○	○	N	N	N
ON/OFF times per week	8 x 7	8 x 7	8 x 7	N	N	N
Annual	N	N	N	N	N	N
Optimized start-up	N	N	N	N	N	N
Auto-OFF timer	○	○	○	N	N	N
Min. timer setting unit (minute)	5	5	5	N	10	10
■Recording						
Error log	○	○	○	N	N	N
Daily/monthly report	N	N	N	N	N	N
Electricity charge	N	N	N	N	N	N
Energy management data	N	N	N	N	N	N
■Other						
Temp-set limitation by Local R/C	○	○	○	○	N	N
Temp-set limitation by System controller	○ *2	○ *2	○	○ *2	N	N
Operation lock	○	○	○	○	N	N
Night setback	N	N	N	N	N	N
Sliding temperature control	N	N	N	N	N	N
■Management (Group/Interlocked)						
Ventilation interlock	N / ○	N / ○	N / ○	N / ○	N	N
Group setting	○ *1	○ *1	○	○ *1	N	N
Block setting	N	N	N	N	N	N
Review of electricity charge	N	N	N	N	N	N
■Operating on Lossnay interlocked (Group/Interlocked)						
ON/OFF	N / ○	N / ○	N / ○	N / ○	N / ○ *3	N / ○ *3
Fan speed	N / ○	N / ○	N / ○	N	N	N
Ventilation mode	N / N	N / N	N	N	N	N
■Status monitoring on Lossnay interlocked (Group/Interlocked)						
ON/OFF	N / ○	N / ○	N / ○	N / ○	N	N
Fan speed	N / ○	N / ○	N / ○	N	N	N
Ventilation mode	N	N	N	N	N	N

○: Each group N: Not Available (Not Used.)

- *1. Group setting via wiring between Indoor units with cross-over cable;
 *2. This function can only be set on the ME remote controller.
 This function cannot be used with the MA/Simple MA remote controller.
 (However, the validity of this function with the MA/Simple MA remote controller depends on the indoor unit model, and it is possible to use this function with them.)
 *3. Interlock is set from system controllers (Except PAC-YT40ANRA) or local remote controllers.
 *4. The maximum number of controllable units decreases depending on the indoor unit model.
 *5. For indoor use only.
 *6. This function is supported only when all of the indoor units, remote controllers, and system controllers that are connected to a given group features said function.
 *7. Icon  When the operation mode is set to Auto (dual set point) mode, two preset temperatures (one each for cooling and heating) can be set. Depending on the room temperature, the indoor unit will automatically operate in either the Cool or Heat mode and keep the room temperature within the preset range.

This function is supported only when all of the indoor units, remote controllers, and system controllers that are connected to a given group features said function. Contact your local distributor for details.

• Operation pattern during Auto (dual set point) mode

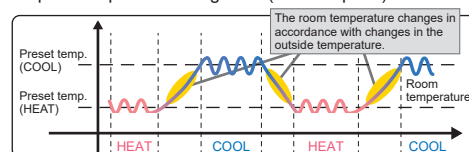

*8. Function setting of this remote controller is necessary.

Model	System controller *5						
	PAC-YT40ANRA	AE-200A/AE-50A		AE-200A + AE-50A/EW-50A		EW-50A	
		16/50	50/50		200/200		50/50
Controllable Groups/Indoors (Group/Indoor) *4		AE-200A	Browser	AE-200A	Browser	EW-50A	Browser
■Operation							
ON/OFF	☉	☉ ■	☉ ■	☉ ■	☉ ■	▲	☉ ■
Mode (cool/heat/dry/fan/auto)	N	☉ ■	☉ ■	☉ ■	☉ ■	N	☉ ■
Mode (Setback) *6	N	☉ ■	☉ ■	☉ ■	☉ ■	N	☉ ■
Temperature setting	N	☉ ■	☉ ■	☉ ■	☉ ■	N	☉ ■
Dual set point *7	○ *8	☉ ■	☉ ■	☉ ■	☉ ■	N	☉ ■
Local Permit/Prohibit	N	☉ ■	☉ ■	☉ ■	☉ ■	N	☉ ■
Fan speed	N	☉ ■	☉ ■	☉ ■	☉ ■	N	☉ ■
Air flow direction	N	☉ ■	☉ ■	☉ ■	☉ ■	N	☉ ■
■Status monitoring							
ON/OFF	☉	☉	○	☉	○	▲	○
Mode (cool/heat/dry/fan)	N	○	○	○	○	N	○
Temperature setting	N	○	○	○	○	N	○
Local Permit/Prohibit	○	○	○	○	○	N	○
Fan speed	N	○	○	○	○	N	○
Air flow direction	N	○	○	○	○	N	○
Indoor temperature	N	○	○	○	○	N	○
Filter sign	N	○	○	○	○	N	○
Error flashing	○	○	○	○	○	▲	○
Error code	○	○	○	○	○	N	○
Operation hour	N	N	N	N	N	N	N
■Scheduling							
One day	N	☉ ■	☉ ■	☉ ■	☉ ■	N	☉ ■
ON/OFF times per day	N	24	24	24	24	N	24
Weekly	N	☉ ■	☉ ■	☉ ■	☉ ■	N	☉ ■
ON/OFF times per week	N	24 x 7	24 x 7	24 x 7	24 x 7	N	24 x 7
Annual	N	☉ ■	☉ ■	☉ ■	☉ ■	N	☉ ■
Optimized start-up	N	○	○	○	○	N	○
Auto-OFF timer	N	N	N	N	N	N	N
Min. timer setting unit (minute)	N	1	1	1	1	N	1
■Recording							
Error log	N	○	○	○	○	N	○
Daily/monthly report	N	N	N	N	N	N	N
Electricity charge	N	N	N	N	N	N	N
Energy management data	N	N	●	N	●	N	●
■Other							
Temp-set limitation by Local R/C	N	N	N	N	N	N	N
Temp-set limitation by System controller	N	N	○ *13	N	○ *13	N	○ *13
Operation lock	N	N	N	N	N	N	N
Night setback	N	○	○ *11	○	○ *11	N	○ *11
Sliding temperature control	N	○	○ *11	○	○ *11	N	○ *11
■Management (Group/Interlocked)							
Ventilation interlock	○	○	○ / ○ *11	○	○ / ○ *11	N	○ / ○ *11
Group setting	○	○	○ *11	○	○ *11	N	○ *11
Block setting	N	○	○ *11	○	○ *11	N	○ *11
Review of electricity charge	N	N	N	N	N	N	N
■Operating on Lossnay interlocked (Group/Interlocked)							
ON/OFF	☉ / ☉ *2	☉ / ☉	☉ / ☉	☉ / ☉	☉ / ☉	▲ / ▲	☉ / ☉
Fan speed	N	☉ / ☉	☉ / ☉	☉ / ☉	☉ / ☉	N / N	☉ / ☉
Ventilation mode	N	☉ / N	☉ / N	☉ / N	☉ / N	N / N	☉ / N
■Status monitoring on Lossnay interlocked (Group/Interlocked)							
ON/OFF	N	☉ / ☉	☉ / ☉	☉ / ☉	☉ / ☉	▲ / ▲	☉ / ☉
Fan speed	N	○ / ○	○ / ○	○ / ○	○ / ○	N / N	○ / ○
Ventilation mode	N	○ / N	○ / N	○ / N	○ / N	N / N	○ / N

☉: Each group/Batched ○: Each group ●: AE-200A/AE-50A/EW-50A license registration possible. N: Not Available (Not Used.) ▲: Batched handling (for maintenance) ■: Block

- *1. Installation possible at Initial setting web browser;
- *2. Interlock is set at Local remote controller.
- *3. This function can only be set on the ME remote controller. This function cannot be used with the MA/Simple MA remote controller. (However, the validity of this function with the MA/Simple MA remote controller depends on the indoor unit model, and it is possible to use this function with them.)
- *4. The maximum number of controllable units decreases depending on the indoor unit model.
- *5. For indoor use only.
- *6. This function is supported only when all of the indoor units, remote controllers, and system controllers that are connected to a given group features said function.
- *7. Icon  When the operation mode is set to Auto (dual set point) mode, two preset temperatures (one each for cooling and heating) can be set. Depending on the room temperature, the indoor unit will automatically operate in either the Cool or Heat mode and keep the room temperature within the preset range.

This function is supported only when all of the indoor units, remote controllers, and system controllers that are connected to a given group features said function. Contact your local distributor for details.

• Operation pattern during Auto (dual set point) mode

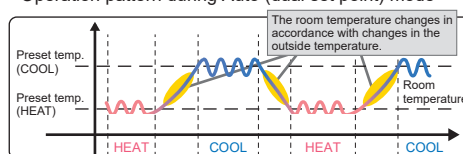

*8. Please contact your local distributor regarding the availability of this function.

MA Touch Remote Controller



PAR-CT01MAU-SB

Dimensions : 2-9/16(W) x 4-3/4(H) x 9/16(D) in.
: 65(W) x 120(H) x 14.1(D) mm

• Example of system configuration

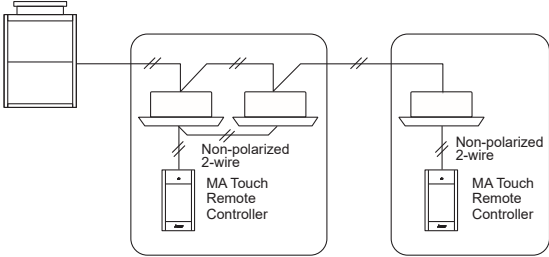

*When a PAR-CT01MAU is connected to a group, no other MA remote controllers can be connected to the same group.

• Multiple color patterns

180 color patterns can be selected for the control parameters and the background of the display.



• Available in a wide variety of colors to suit the decor of any room.



• Language selection

The screen's display language can be selected from 3 languages. (English, French, Spanish)

• Full color touch panel & backlit display

Large icons ensure visibility on the full-color touch panel display.



Touch Panel

3.5 inch/HVGA Full Color LCD



• Operation panels



Temperature setting



Operation mode



Fan speed



Vane control



Ventilation



Louver control

• **Bluetooth® low energy technology**

The remote controller can communicate with a smartphone or tablet device via Bluetooth Low Energy. User and setting apps are available.

* Bluetooth® is a trademark of Bluetooth SIG, Inc. in the U.S.
 * Contact a Bluetooth sales company for information on the Bluetooth function.



<User App>

▶ For iPhone
 Available on the **App Store**
 * For iOS (11.0 or later)

▶ For Android
GET IT ON Google Play
 * For Android (7.0 or later) **

<Setting App>

▶ For iPhone
 Available on the **App Store**
 * For iOS (11.0 or later)

▶ For Android
GET IT ON Google Play
 * For Android (7.0 or later) **

To download the app, scan the QR code. *QR code is a registered trademark of DENSO WAVE INCORPORATED.
 **1 The app may not function properly on some mobile devices.

• **Functions**

○ : Available ✕ : Not available

Item	Description	Setting	Display
ON/OFF	Switches between ON and OFF.	○	○
Operation mode switching	Switches between Cool/Dry/Fan/Auto/Heat.	○	○
Hold	Switches between enable and disable the Hold function. If the Hold function is enable, the following functions will be prohibited. Timer/Schedule (Weekly timer) /Auto return/Auto-OFF timer	○	○
Temperature setting	Changes the set temperature. * Set temperature range varies depending on the indoor unit model.	○	○
Air flow direction setting	Changes airflow direction. * Available airflow directions vary depending on the model.	○	○
Fan speed setting	Changes fan speed. * Available fan speeds vary depending on the model.	○	○
Louver setting	Switches between louver ON/OFF.	○	○
Ventilation equipment control	Interlocked setting and interlocked operation setting with CITY MULTI Lossnay units can be performed. The Stop/Low/High settings of the ventilation equipment can be controlled.	○	○
Error information	When an error occurs, an error code and the unit address appear. Air conditioning unit model, serial number, and contact number can be set to appear when an error occurs. (The information above needs to be entered in advance.) * An error code may not appear depending on the error.	—	○
Timer	ON/OFF timer Turns ON and OFF daily at a set time. • Time can be set in 5-minute increments. • It is also possible to set the ON time only or the OFF time only. Auto-OFF timer Turns off the unit after a certain period of operation. • Operation time can be set to a value from 30 to 240 minutes in 10-minute increments.	○	○
Allows/disallows local operation	The following operation can be prohibited by applying certain settings on the centralized controller: ON/OFF, operation mode setting, temperature setting, fan speed, air direction, and filter sign reset. * While an operation is prohibited, the operation icon lights up (only on the Main display in "Full" mode).	✕	○
Operation lock	The following operations can be prohibited: "Location," "On/Off," "Mode," "Set temp.," "Menu," "Fan," "Louver," or "Vane."	○	○
Temperature range restriction	The room temperature range for each operation mode can be restricted.	○	○
Auto return	The units operate at the preset temperature after a designated period. (Time can be set to a value from 30 to 120 minutes in 10-minute increments.) * Not valid when the temperature setting range is restricted.	○	✕
Daylight saving time	The start/end time for daylight saving time can be set. The daylight saving time function will be activated based on the settings.	○	✕
Weekly timer	Weekly ON/OFF times and set temperatures can be set. • Time can be set in 5-minute increments. Up to 8 schedule patterns can be set per day of the week. * Not valid when the ON/OFF timer is set.	○	○
Bluetooth connection, Bluetooth, Screen update	The Bluetooth connection information can be acquired. Using an Application, a logo image as well as settings data can be sent to the remote controller.	○	○

Wired MA Remote Controller



Dual Set Point

PAR-41MAAU

Dimensions: 4-23/32(W) x 4-23/32(H) x 37/64(D) in.
: 120(W) x 120(H) x 14.5(D) mm

• **Backlit LCD (Liquid Crystal Display)**

Large, easy-to-see display.
The screen background can be changed to black to suit the ambience of the room.

• **3D i-see Sensor***

Settings can be made for the 3D i-see Sensor.

• **Draft reduction***

“Close” has been added to the manual vane angle selection.
The air outlet can be closed to reduce drafts from the air conditioner.

• **Auto descending panel***

Panels can be lowered/raised using the remote controller.
Panel position can also be selected from a number of patterns.

*Availability of the function depends on the indoor unit model. Contact your local distributor for details.

• **Example of system configuration**

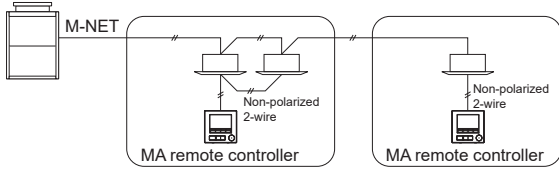

*When a PAR-41MAAU is connected to a group, no other MA remote controllers can be connected to the same group.

• **Functions**

○ : Available × : Not available

Item	Description	Setting	Display
ON/OFF	Switches between ON and OFF.	○	○
Operation mode switching	Switches between Cool/Dry/Fan/Auto/Setback/Heat.	○	○
Hold	Switches between enable and disable the Hold function. If the Hold function is enable, the following functions will be prohibited. ON/OFF timer/Schedule (Weekly timer) /Auto return/Auto-OFF timer	○	○
Temperature setting	Changes the set temperature. * Set temperature range varies depending on the indoor unit model.	○	○
Air flow direction setting	Changes airflow direction. * Available airflow directions vary depending on the model.	○	○
Louver setting	Switches between louver ON/OFF.	○	○
Ventilation equipment control	Interlocked setting and interlocked operation setting with CITY MULTI Lossnay units can be performed. The Stop/Low/High settings of the ventilation equipment can be controlled.	○	○
Error information	When an error occurs, an error code and the unit address appear. The air-conditioning unit model, serial number, and contact number can be set to appear when an error occurs. (The above information needs to be entered in advance.) * An error code may not appear depending on the error.	—	○
Timer	ON/OFF timer Turns ON and OFF daily at a set time. • Time can be set in 5-minute increments. • It is also possible to set the ON time only or the OFF time only. Auto-OFF timer Turns off the unit after a certain period of operation. • Operation time can be set to a value from 30 to 240 minutes in 10-minute increments.	○	○
Allows/disallows local operation	The following operation can be prohibited by applying certain settings on the centralized controller: ON/OFF, operation mode, set temperature, filter sign reset, air direction, fan speed and timer. * While an operation is prohibited, the operation icon lights up (only on the Main display in the "Full" mode).	×	○
Operation lock	The following operations can be prohibited: "Location," "On/Off," "Mode," "Set temp.," "Menu," "Fan," "Louver," or "Vane."	○	○
Temperature range restriction	The room temperature range for each operation mode can be restricted.	○	○
Auto return	The units operate at the preset temperature after a designated period. (Time can be set to a value from 30 to 120 minutes in 10-minute increments.) * Not valid when the temperature setting range is restricted.	○	×
Daylight saving time	The start/end time for daylight saving time can be set. The daylight saving time function will be activated based on the setting contents.	○	×

ME Remote Controller

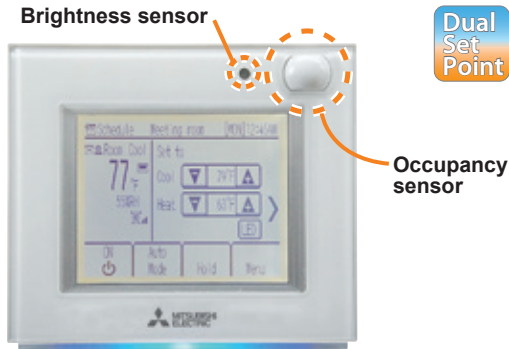

PAR-U01MEDU

Dimensions : 5-9/16(W) x 4-3/4(H) x 1(D) in.
: 140(W) x 120(H) x 25(D) mm

• System configuration example

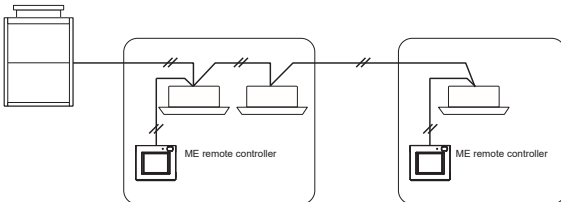

- **Occupancy sensor**
Detects vacancy for energy-save control.
- **Touch panel & backlit LCD**
Shows the operation settings screen.
When the backlight is off, touching the panel turns it on, and it will stay lit for a prespecified period of time.
- **LED indicator**
Shows the operation status in different colors.
It lights up during normal operation, turns off when units are stopped, and blinks when an error occurs.
- **Brightness sensor**
Detects the brightness of the room for energy-save control.
- **Temperature & humidity sensor**
Detects room temperature and relative humidity.
- **Device control via AHC (Advanced HVAC Controller)**
Allows control of other manufacturer's products connected via AHC.
- **Auto (dual set point) modes**
Two temperatures (one each for cooling and heating) can be set.

Occupancy sensor detection zone

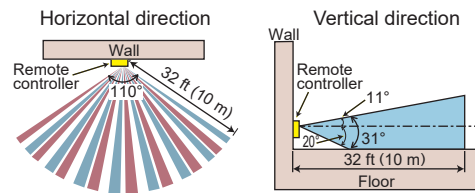

• Functions

○:Available ×:Not available

Item	Description	Setting	Display
ON/OFF	Switches between ON and OFF.	○	○
Operation mode switching	Switches between Cool / Dry / Fan / Heat / Setback / Auto. Operation modes vary depending on the indoor unit model. Auto mode is for CITY MULTI R2, H2i R2 and WR2-Series only.	○	○
Temperature setting	Changes the set temperature. * Set temperature range varies depending on the indoor unit model.	○	○
Fan speed setting	Changes fan speed. * Available fan speeds vary depending on the model.	○	○
Air flow direction setting	Changes airflow direction. * Available airflow directions vary depending on the model.	○	○
Allows/disallows local operation	The following operation can be prohibited by applying certain settings on the centralized controller: ON/OFF, operation mode setting, temperature setting, fan speed, air direction, and filter sign reset. * While an operation is prohibited, the operation icon lights up.	×	○
Error information	When an error occurs, an error code and the unit address appear. A contact number can be set to appear when an error occurs. (The above information needs to be entered in the Service menu.)	—	○
Schedule (Weekly timer)	Weekly ON/OFF times, operation mode, and set temperatures can be set. • Time can be set in 5-minute increments. Up to 8 schedule patterns can be set per day of the week. * Not valid when the ON/OFF timer is set.	○	○
Timer	ON/OFF timer • Turns ON and OFF daily at a set time. • Time can be set in 5-minute increments. • It is also possible to set the ON time only or the OFF time only. Auto-OFF timer • Turns off the unit after a certain period of operation. • Operation time can be set to a value from 30 to 240 in 10-minute increments.	○	○
Energy-save control during vacancy	When vacancy is detected by the occupancy sensor, the energy-save control assist function is activated. Four control types are available for selection: ON/OFF/Set temperature/Fan speed/Thermo-off. The brightness sensor can be used in conjunction with the occupancy sensor to detect the occupancy/vacancy status more accurately.	○	○

Wireless Remote Controller



PAR-FL32MA
Dimensions: 2-5/16(W) x 6-5/16(H) x 3/4(D) in.
: 58(W) x 159(H) x 19(D) mm



PAR-SL101A-E
(PLFY-EP NEMU1, PLFY-P NFMU only)
Dimensions: 2-5/8(W) x 7-13/32(H) x 7/8(D) in.
: 66(W) x 188(H) x 22(D) mm



PAR-FA32MA
Dimensions: 2-3/4(W) x 4-3/4(H) x 7/8(D) in.
: 70(W) x 120(H) x 22.5(D) mm



PAR-SR4LU-E
(4-way cassette signal receiver)
Dimensions: 7-5/16(H) x 1-5/32(D) in.
: 185(H) x 29(D) mm



PAR-SF9FA-E
(2 x 2 cassette signal receiver)
Dimensions: 8-7/16(H) x 1-1/32(D) in.
: 214(H) x 25.5(D) mm



PAR-SL94B-E
(Wireless remote controller kit for ceiling suspended type)
Dimensions: 7-3/16(W) x 2-1/4(H) x 1-1/4(D) in.
: 182(W) x 57(H) x 31(D) mm

- No need to configure addresses for group operation.
- The LED remains lit to show operation status. It also provides error information via the number of blinks.
- Can be used with the MA remote controller.
- *When used in group configurations, wiring is required between indoor units.
- *ME remote controllers and Lossnay remote controllers cannot be combined in the same group.
- Multiple indoor units cannot be controlled with the PAR-SL101A-E.
- Only one indoor unit can be used in each group.
- LCD temperature setting and display in 1°C/1°F increments.

• System configuration example

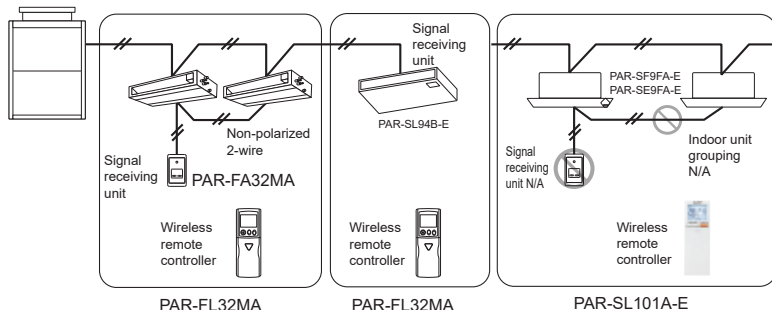

Compatibility table

Indoor unit model	Receiver	Transmitter
PMFY-P NBMU-E PFFY-P NEMU / NRMU-E PEFY-P NMSU-E PEFY-P NMAU-E4/E5 PEFY-PNMH(S)U-E(2)	PAR-FA32MA	PAR-FL32MA

Indoor unit model	Receiver	Transmitter
PCFY-P NKMU-E PKFY-P NLMU-E PKFY-P NKMU-E2	PAR-FA32MA PAR-SL94B-E *1 Built-in	PAR-FL32MA
PLFY-EP NEMU1-E(1) *3	PAR-SR4LU-E	PAR-FL32MA PAR-SL101A-E *4
PLFY-P NFMU-E *3	PAR-FA32MA PAR-SF9FA-E	PAR-FL32MA *2 PAR-SL101A-E *4

*1 PAR-SL94B-E includes a wireless remote controller.
*2 PAR-SL101A-E is required to use the direct/indirect setting and individual vane setting.
*3 Use either PAR-SL101A-E or PAR-FL32MA to control each indoor unit, not both.
*4 Multiple indoor units cannot be controlled with the PAR-SL101A-E. Only one indoor unit can be used in each group.

• Functions

○ : Available × : Not available

Item	Description	Setting	Display
ON/OFF	ON and OFF operation for a single group	○	○
Temperature setting	Changes the set temperature. * Set temperature range varies depending on the indoor unit model.	○	○
Air flow direction setting	Air flow direction angles (4-angle, Swing) Auto Louver ON/OFF. Air flow direction settings vary depending on the model. *1 Some models will have a different display for the air flow direction and fan speed. Set the air-flow direction and fan speed when performing initial settings.	○*1	○*1
Timer operation	One ON/OFF setting can be set per day.	○	○
Permit / Prohibit local operation	Individually prohibit operation of each local remote control function (ON/OFF, Change operation mode, Set temperature, Reset filter). *2 If operation is performed when the local remote controller inactivation command is received from the main system controller, a buzzer will sound and an LED will flash.	×	○*2

Simple Remote Controller

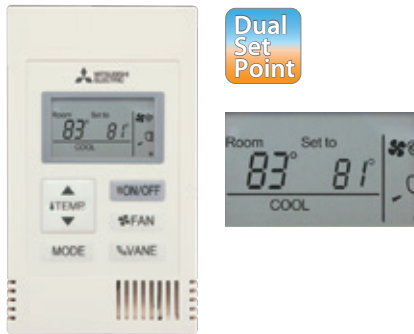

PAC-YT53CRAU (MA)

Dimensions: 2-3/4(W) x 4-3/4(H) x 19/32(D) in.
: 70(W) x 120(H) x 14.5(D) mm

• System configuration example

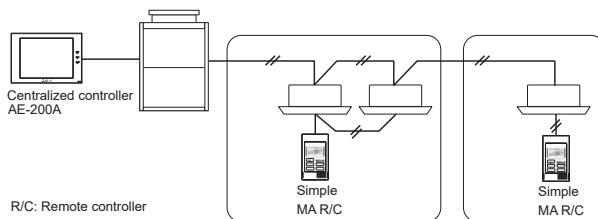

• Dual set point

When the operation mode is set to Auto (dual set point) mode, two preset temperatures (one each for cooling and heating) can be set. Depending on the room temperature, the indoor unit will automatically operate in either the Cool or Heat mode and keep the room temperature within the preset range.

*Contact your Mitsubishi Electric sales office for details.

• Backlit LCD

Backlight for operation in dark places

• Flat back

The remote controller can be installed without making a hole in the wall.

Thickness is less than 19/32 in (14.5 mm).

• Vane button (standard)

The Vane button has been added to allow users to change airflow direction (ceiling cassette and wall mounted types).

Pressing the  button changes the vane direction.

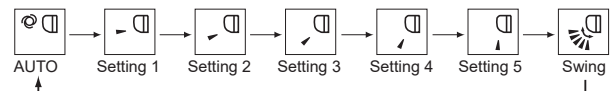

*The vane directions that can be set vary depending on the indoor unit model.

*If the unit has no vane function, vane direction cannot be set.

In this case, the vane icon blinks when the  button is pressed.

• Only cross-over wiring is required, based on two-wire signal lines.

• Room temperature sensors are built in.

• Compatible with all types of indoor units

*As this controller has limited functions, it should always be used in conjunction with a standard controller or centralized controller.

• LCD temperature setting and display in 1°F/1°C increments

• Functions

○ : Available × : Not available

Item	Description	Setting	Display
ON/OFF	Changes between ON and OFF.	○	○
Operation mode switching	Select from COOL, DRY, FAN, AUTO, Setback, and HEAT. * Auto mode and Setback mode are for CITY MULTI R2, H2i R2, and WR2-Series only.	○	○
Temperature setting	Changes the set temperature. * Set temperature range varies depending on the indoor unit model.	○	○
Fan speed setting	Changes the fan speed. * The settable fan speed varies depending on the indoor unit model to be connected.	○	○
Permit / Prohibit local operation	By setting a centralized controller, the following local operations can be prohibited: ON/OFF, operation mode, preset temperature; * The CENTRAL icon appears while local operations are prohibited.	×	○
Error	Displays the current error status with the address. * The address may not be displayed depending on the error status.	—	○
Ventilation equipment	When the CITY MULTI indoor unit is connected, interlocked setting of the CITY MULTI Lossnay unit is possible.	○	○
Set temperature range limit	The preset temperature range can be restricted for each operation mode (COOL/HEAT/AUTO).	○	○

Centralized Controller

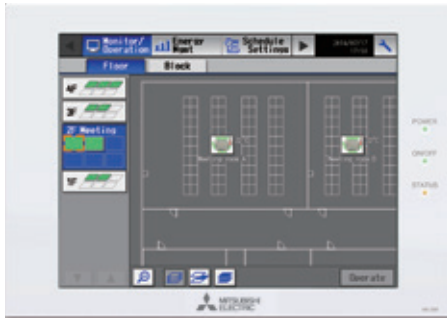

AE-200A/AE-50A

Dimensions: 11-3/16(W) x 7-7/8(H) x 2-9/16(D) in.
: 284(W) x 200(H) x 65(D) mm



- **Promotes energy savings through the comprehensive display of the energy consumption of air-conditioning equipment.**
 - The energy consumption of air-conditioning equipment can be displayed by individual area in graph form for easy viewing.
 - Operating status can be easily confirmed by comparing power consumption with the previous year and with the electrical power target.
 - Floor layout is displayed on the 10.4-inch LCD touch panel for easy management of air-conditioning equipment.
 - **An optimal system can be easily and flexibly established according to the size of the facility.**
 - Up to 50 indoor units can be managed.
 - Centralized control of up to 200 indoor units can be performed with three "AE-50A/EW-50A" expansion controllers.
 - More than 200 indoor units can be managed by connecting the PC to a web browser.*1
- *1. Contact your local distributor regarding support for this feature.
- **Features for operating and monitoring the hot water heat pump in PWFY models are also available.**
 - Centralized batch control of PWFY is possible in addition to individual control of each air-conditioning unit.

• Control screens for power consumption



Energy consumption of a targeted area is displayed by month, day, and hour. Energy consumption of two different units, groups, and blocks can be compared. Fan operation time and energy consumption can be displayed.



The energy consumption of each air-conditioning equipment is ranked and displayed by area, thus visualizing high-load components. Energy consumption can also be compared with electrical energy targets.

• Comparison of the number of connectable units

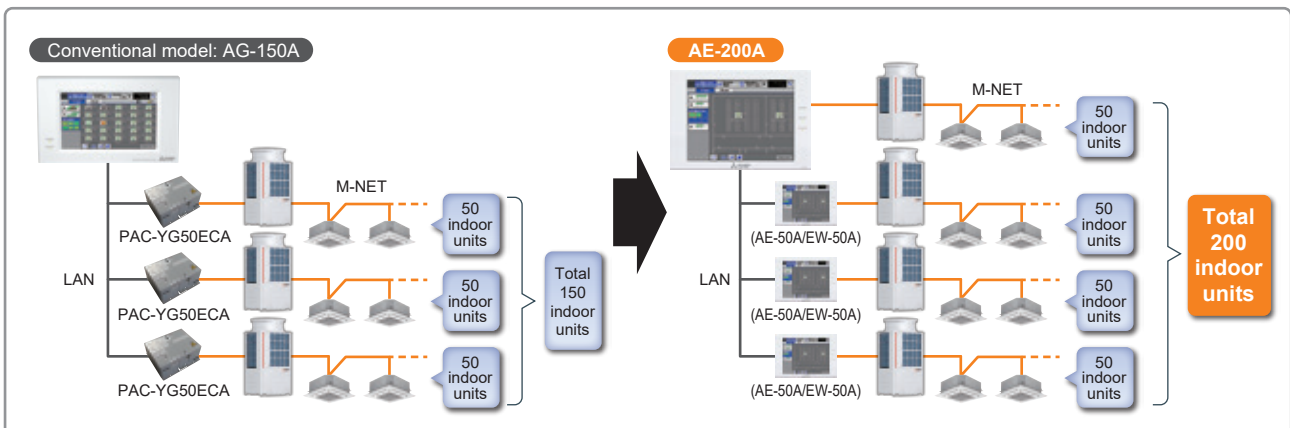

• System structure

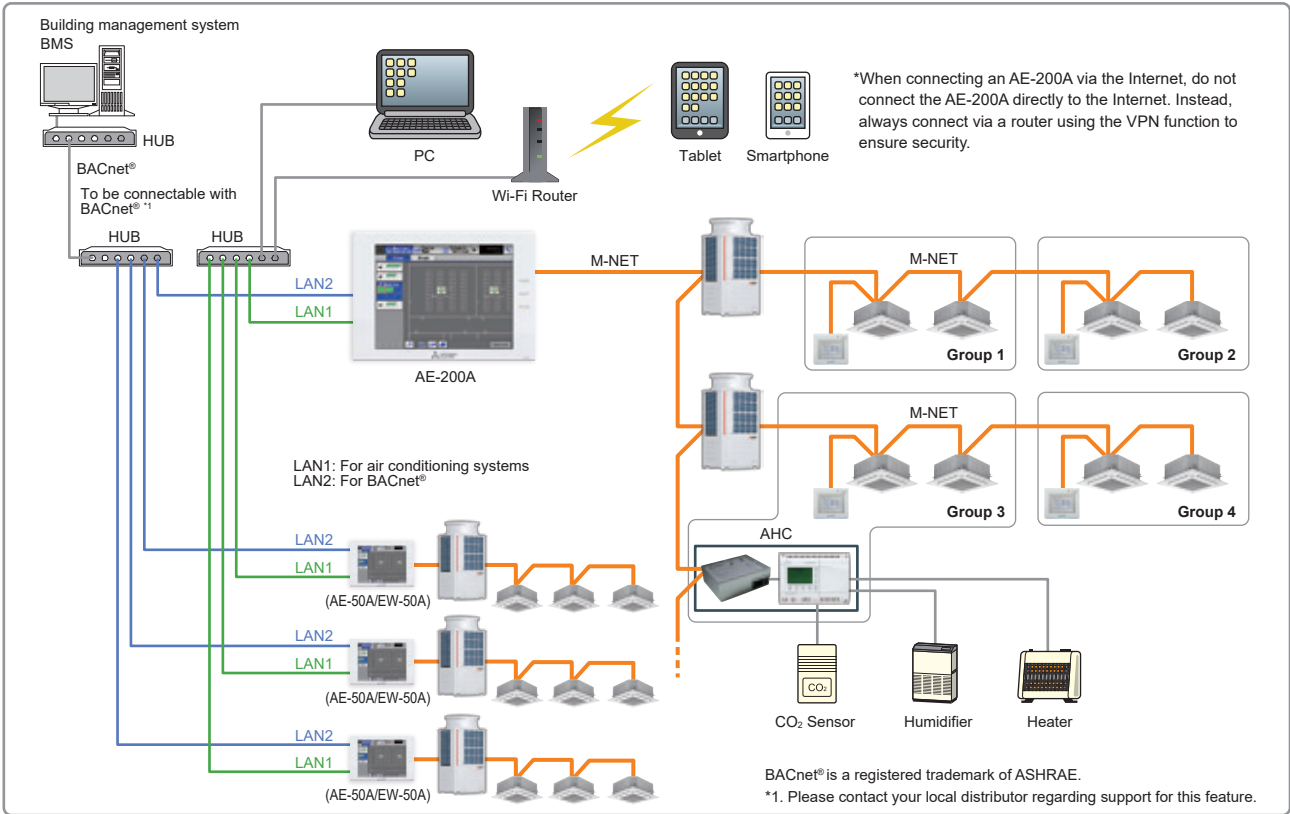

• Functions

□ : Each unit ○ : Each group ● : Each block △ : Each floor ● : Collective × : Not available

Item	Description	Setting	Display
Controllable number of units	Up to 50 units/50 groups		
ON/OFF	ON and OFF operation for the air conditioning units and general equipment. (PAC-YG66DCA is required to operate general equipment.)	○ ○ △ ●	○ ○
Operation mode	Switches between several operation modes depending on the air conditioning unit. Air conditioning unit: Cool/Dry/Auto(*)/Fan/Heat/Setback Lossnay unit: Heat Recovery/Bypass/Auto Air To Water (PWFY) units: Heating, Heating ECO, Hot Water, Anti-freeze, Cooling * Auto mode is for CITY MULTI R2 and WR2-Series only.	○ ○ △ ●	○
Temperature setting	Changes the set temperature. * Set temperature range varies depending on the indoor unit model.	○ ○ △ ●	○
Fan speed setting	Models with 4 air flow speed settings : Hi/Mid-2/Mid-1/Low Models with 3 air flow speed settings : Hi/Mid/Low Models with 2 air flow speed settings : Hi/Low Fan speed setting (including Auto) varies depending on the model.	○ ○ △ ●	○
Air flow direction setting	Air flow direction angles, 4-angles or 5-angles Swing, Auto (Louver cannot be set)	○ ○ △ ●	○
Schedule operation	Weekly schedule can be set by groups based on daily operation pattern.	○ ○ △ ●	○
Permit/prohibit local operation	Individually prohibits operation of each local remote controller function. (ON/OFF, Operation mode, Set temperature, Filter sign reset, Air Direction*, Fan Speed*, Timer*) * This function depends on the model.	○ ○ △ ●	○
Indoor unit intake temperature	Measures the intake temperature of the indoor unit only when the indoor unit is operating.	×	○
Error	When an error is currently occurring on an air conditioning unit, the affected unit and the error code are displayed.	×	□ ○ ●
Test run	This operates air conditioning units in test run mode.	○ ○ △ ●	○
Ventilation interlock	The ventilation unit (Lossnay) is able to automatically start its operation when operation of the interlocked indoor unit starts.	○ ○ △ ●	○
External input/output	By using optional external input/output adapter (PAC-YG10HA-E) you can set and monitor the following: Input : By level signal : "Batch ON/OFF", "Batch emergency stop" By pulse signal : "Batch ON/OFF", "Enable/disable local remote controller" Output : "ON/OFF", "Error/Normal"	○	○
Energy Management	Bar Graph : Indoor unit Electric Energy, FAN operation time, Thermo-ON time (TOTAL, Cooling, Heating) can be displayed hourly, daily, and monthly. Line Graph : Outdoor temp., Room temp., Set temp. (Heating, Cooling) input from PAC-YG63MCA and temp. from AHC.	×	□ ○ ●
Advanced HVAC Controller (AHC)	The status of AHC can only be monitored.	×	○
ME remote controller	The status of sensor on this controller can be monitored.	×	○
Smartphone/Tablet	The specified web browser on iOS and Android OS can monitor and operate the AE-200A/AE-50A/EW-50A.	○	○
Web design	Web screen design for a user friendly interface.	○ ○ △ ●	○
Initial setting software	The initial setting can be configured without the connection of AE-200A/AE-50A/EW-50A.	×	×
Apportionment of power consumption	Apportionment of power consumption can be calculated on AE-200 without TG-2000A. *1	●	□ ○ ●
BACnet® communication	ANSI/ASHRAE 135-2010 (ISO16484-5) is supported and approved by the BTL.	○	×

*1. Even when the number of indoor units is 50 or less, the system must consist of AE-200A and EW-50A/AE-50A.
AE-200A M-NET cannot be used.

Centralized Controller



EW-50A

Dimensions: 8-1/4(W) x 6-25/32(H) x 3-5/8(D) in.
: 209(W) x 172(H) x 92(D) mm

• System structure

System diagram (standard)

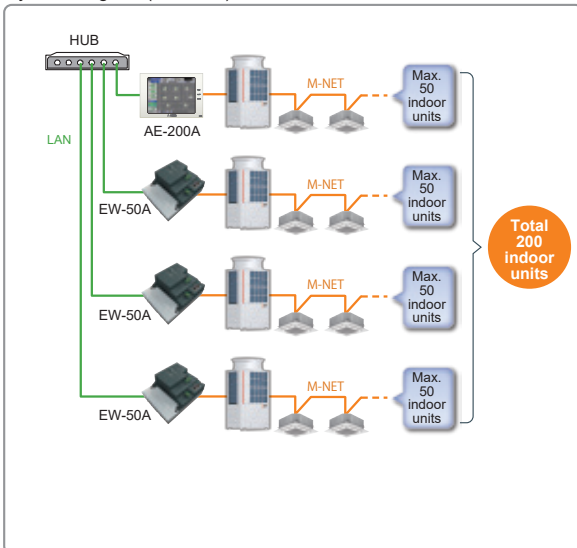

* When the AE-200A M-NET is not used, a maximum of four EW-50A units can be connected.

• Main Features

Can be used as an expansion controller for the AE-200A

Up to 200 indoor units can be operated and monitored by connecting three EW-50A units to an AE-200A controller.

Apportionment of electricity charges

The power consumption of each air conditioner can be calculated with an AE-200A controller. The calculated data can be output to a PC via a USB memory device or LAN, and billing charges can be prepared using a specific charge calculation tool.

*The function to apportion electricity charge requires the use of both the AE-200A and EW-50A.

*For other restrictions, refer to the Installation Manual and Instruction Book.

System diagram (with charge setting)

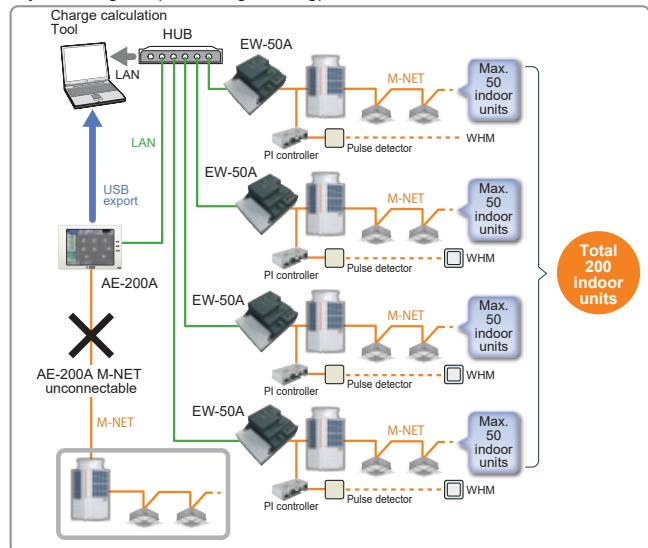

* Even when the number of indoor units is 50 or less, the system must consist of AE-200A and EW-50A/AE-50A.

• Air conditioner units can be operated and monitored independently using a PC

Even without an AE-200A controller, the EW-50A can operate and monitor air-conditioner units using browser software¹.

Air conditioners can be operated and monitored remotely via the Internet. In addition, air conditioners in multiple buildings can be collectively operated.²

* 1. This operation has been confirmed on Internet Explorer 11, Edge 44, Google Chrome ver.83, and Safari13.

Microsoft® Internet Explorer is a trademark or registered trademark of Microsoft Corporation in the U.S. and other countries.

Google is a registered trademark of Google LLC.

Google Chrome is a registered trademark of Google LLC. in the U.S. and other countries.

Edge is a trademark or registered trademark of Microsoft Corporation in the U.S. and other countries.

Internet Explorer is a trademark or registered trademark of Microsoft Corporation in the U.S. and other countries.

Windows is a trademark or registered trademark of Microsoft Corporation in the U.S. and other countries.

Safari is a trademark or registered trademark of Apple Inc. in the U.S.

Company names and product names in this brochure may be trademarks or registered trademarks of the respective rights holder.

* 2. When connecting an EW-50A via the Internet, do not connect the EW-50A directly to the Internet. Instead, always connect via a router using the VPN function to ensure security.

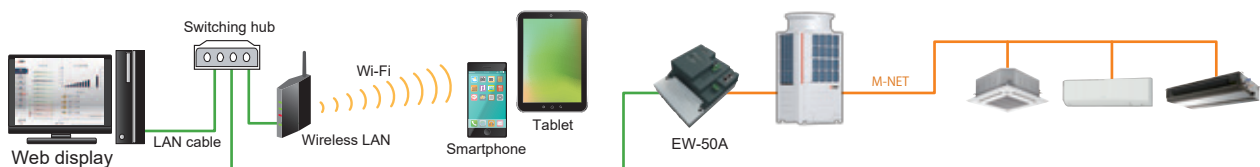

• **Management of air conditioner usage conditions**

The energy consumption of air conditioners can be displayed in an easy-to-understand manner using a web browser.

* The billing function requires a PI Controller and watt-hour meter with pulse transmitter (procured locally).



• **Operable without a transmission line power supply unit**

The EW-50A unit is equipped with a power supply function. Power supplied by a transmission line power supply unit is not necessary. Since an outside power supply is not needed, self-sustained operation is possible even when the outdoor unit system is down. (In cases where the power consumption factor exceeds 1.5, a power supply unit is needed.)

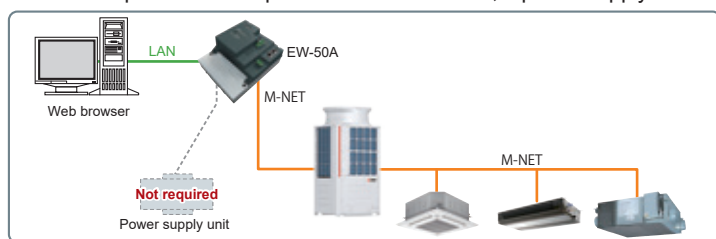

• **Energy-saving control**

With the addition of an energy-saving control license (optional product), the temperature setting can be automatically changed*¹ according to the room temperature around the air-conditioner unit to allow greater energy savings without sacrificing comfort.

* 1. With this function, the temperature setting can be changed in +2°F/2°C increments for cooling and -2°F/2°C increments for heating during a set time interval. In cases where the intake temperature and temperature setting are significantly different, exclusion from the energy-saving target is possible.

• **Functions**

* Functions and specifications are subject to change.

◎ : By group or multiple groups ○ : By group □ : Batch only

Item	Remarks	Setting	Display
ON/OFF	Switches air conditioners and general equipment ON or OFF.	◎	◎
Operation mode switching	Switches to cool, dry, auto, fan, or heat operation. * Some modes are not available depending on the unit.	◎	◎
Room temperature setting	Changes the set temperature. * Set temperature range varies depending on the indoor unit model.	◎	○
Set temperature 1°F/0.5°C increments	The temperature can be set and displayed in 1°F/0.5°C increments. * With some unit combinations, the temperature is set in 1°F/1°C increments.	◎	○
Fan speed setting	The fan speed can be set to 4 levels, 3 levels, 2 levels, or automatic. * Available fan speeds differ depending on the unit.	◎	○
Air direction setting	Fixed swing in 5 levels or auto air direction can be set. * Available air directions differ depending on the unit.	◎	○
Prohibition of local remote controller operation	It is possible to disable the ability to use to local remote controllers to run or stop the operation mode, set temperature, filter sign reset, wind speed, wind direction and timer operation. * In the Lossnay group, only ON/OFF and filter reset can be disabled. * Disabling of the fan speed, air direction, and timer operation can be set for the PAR-CT01MAU, PAR-U01MEDU, and PAC-YT53CRAU models.	◎	○
Room temperature display	Displays the suction temperature of the indoor unit.	—	○
Error display	Displays the current error content together with the address.	—	◎
Schedule operation	Today/weekly/weekly by season/yearly Setting content: ON/OFF, operation mode, set temperature, disable local remote controller, air direction/fan	◎	○
Energy management	Displays the power consumption* or operating hours. * Optional part required.	—	◎
Ventilator operation (solo)	Group operation is possible for free plan Lossnay units only. * The group operation mode includes auto ventilation, heat exchange, and normal ventilation.	◎	○
Ventilator operation (interlocked)	Free plan Lossnay units and indoor units can be interlocked and operated together. * At this point, air volume can be operated, but the ventilation mode cannot be selected.	◎	○
External input (timer connection, emergency stop input, etc.)	Using a level signal or pulse signal, it is possible to input the following: Level signal: Emergency Stop Input, Batch ON/OFF, and Demand Input. Pulse signal: Batch ON/OFF or Operation Disable/Enable * Requires an external power supply and external I/O adapter (PAC-YG10HA-E) sold separately. Only one input can be selected from the above inputs.	□	—
External output (error output, operation output)	Using the level signal, ON/OFF, and Error/Normal are output. * Requires an external power supply and external I/O adapter (PAC-YG10HA-E) sold separately.	—	□
Web browser	Monitor/operation, failure, filter sign monitoring, schedule setting, interlocked control setting (option), energy-saving control setting (option), energy-saving peak cut setting (option), set temperature range restrictions, other	◎ ^{*1}	◎ ^{*1}
Filter reset	Filter sign reset	○	○
Connectable location	Centralized system transmission line: Connectable Recommended Indoor and outdoor transmission line: Connectable	—	—

* Functions and specifications differ depending on the connected equipment and model.
* Electric energy can be proportionally divided using the EW-50A alone.
However, the apportioned electricity charge function requires an AE-200A.

■ Notes
* 1. Some items do not support the multi group setting and display.

■ Connectable equipment: CITY MULTI
A Control Mr. Slim (Can be connected using an M-NET adapter or special outdoor unit)
Room air conditioner (Requires a system control interface or M-NET control interface)
Lossnay
AI controller, PI controller, DIDO controller

ON/OFF Remote Controller

Just press a switch to start. All units can be switched ON/OFF by pressing the main switch, and each unit in the group can be switched ON/OFF with individual switches. The PAC-YT40ANRA also has a hardwired connection available (ON/OFF input, fire alarm input, run output, fault output).



PAC-YT40ANRA

Dimensions: 5-1/8(W) x 4-3/4(H) x 3/4(D) in.
: 130(W) x 120(H) x 19(D) mm

• System example

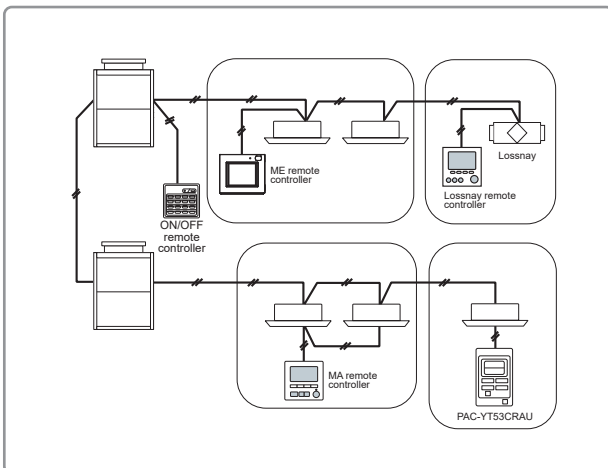

• Control of up to 16 groups/50 indoor units

- Up to 16 groups/50 units can be operated with a single ON/OFF remote controller.
- A general-purpose interface is also available for turning ON/OFF general devices.

• Just press a switch to start

- All units can be started and stopped by pressing the main switch, and each unit in the group can be started and stopped with individual switches.

• LED flashing during failure

- Any error in an air conditioner can be easily confirmed by the flashing of the LED. The LED also indicates whether each group is running or stopped.

• Interlock operation with an external system

- On/off operation can be flexibly interlocked with a card reader, fire alarm system, or building management system, etc. using the external input/output function.

• Flexible group settings

- Groups can be easily configured, allowing group patterns to be set freely according to the layout.
- The ON/OFF remote controller can be connected to the indoor/outdoor transmission line without a power supply unit.

NOTE

The dual set point function is available depending on the controller version.

Contact your local distributor regarding the availability of this function.

• Function

○: Each group □: Batch only ×: Not available

Item	Description	PAC-YT40ANRA	
		Setting	Display
UNITS	Max No.Units	50 units/16 groups	
ON/OFF	ON and OFF operation	○	○
Error indication	LED flashes during failure. (The error code can be confirmed by removing the cover.)	×	○
Ventilation operation (Independent)	Group operation is only possible with Lossnay units. *Only ON/OFF of group.	○	○
Ventilation operation (Interlocked)	The Lossnay will run in interlock with the operation of the indoor unit. *The fan rate and mode cannot be changed. The LED will turn ON only during operation after interlocking.	○	○
External input	ON and OFF operation / Fire Alarm*	□	×
External output	ON and OFF operation / Faults*	×	□

* Applicable to collective only
Not applicable to groups

PI Controller



PAC-YG60MCA

Dimensions: 7-7/8(W) x 4-3/4(H) x 1-13/16(D) in.
: 200(W) x 120(H) x 45(D) mm

The PI controller counts pulses from a power meter, gas meter, water meter, and calorimeter. By combining the AE-200A/AE-50A/EW-50A, the charges for each unit can be calculated and peak cut (e.g., demand control) operations can be performed. The meters can be monitored on the AE-200A/AE-50A LCD.

Energy Saving Control (Peak Cut)

The PI controller enables energy saving control. (Registration of the "Energy management license pack" is required.)

Energy saving is achieved by controlling the capacity of the outdoor unit.

*Note that when using energy saving control, there are no warranties for failures such as usages exceeding the contracted electricity amount.

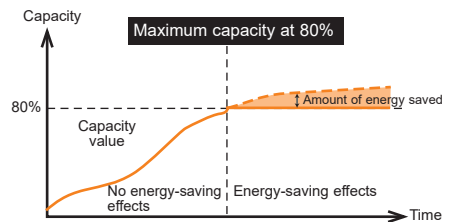

• System structure

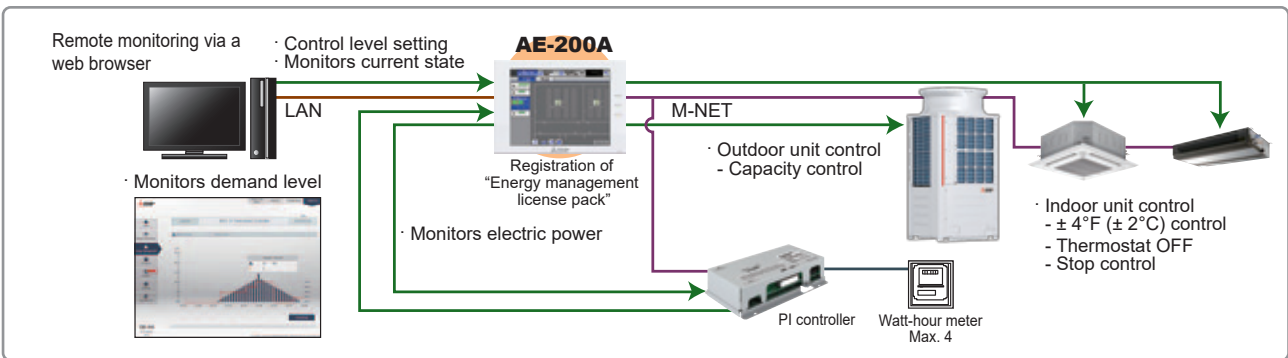

Charge Calculation

• System structure

The charges for each tenant are calculated and output as a CSV file.

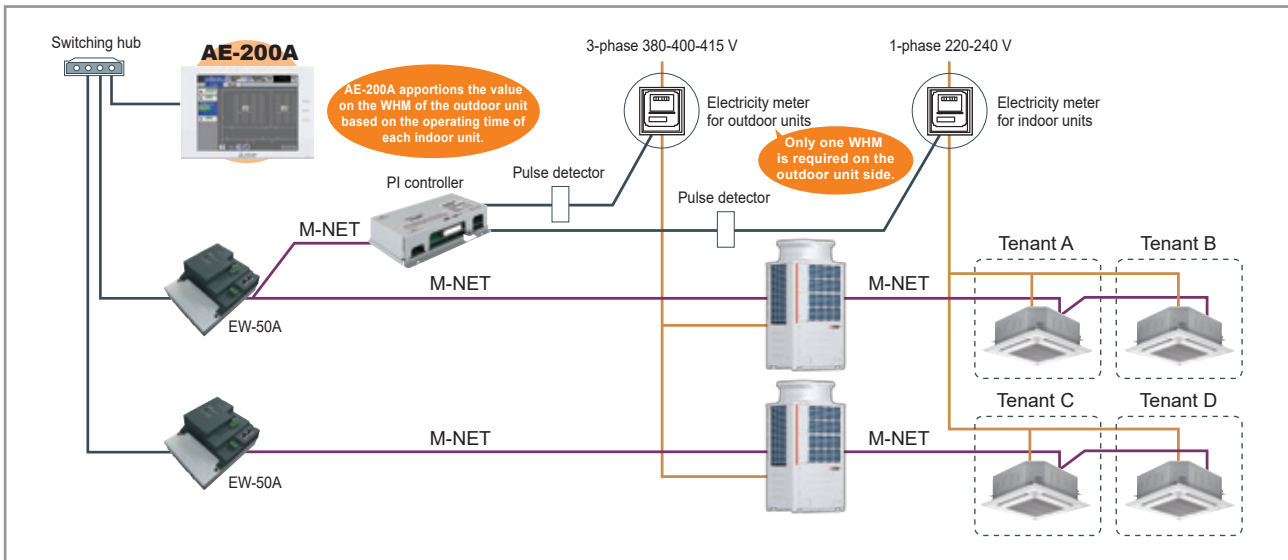

DIDO Controller



PAC-YG66DCA

Dimensions: 7-7/8(W) x 4-3/4(H) x 1-13/16(D) in.
: 200(W) x 120(H) x 45(D) mm

The DIDO controller is used in combination with the AE-200A/AE-50A/EW-50A to operate general-purpose equipment, as well as to monitor operating and error status. It is equipped with two sets of standard terminals (Channels 1 and 2), and four sets of expansion connectors for the input/output terminals.

The expansion cable is optional.

Operation can be monitored or performed from the AE-200A/AE-50A LCD. In addition, this device includes a function that interlocks M-NET devices such as indoor units, general equipment, etc.

Control of general-purpose equipment

Equipment other than air conditioners (air conditioners of other companies, lights, ventilators, etc.) can be controlled and monitored.

- In addition to the above, air conditioners can be interlocked with general-purpose equipment.
E.g.: Interlock between indoor units and a security system
- Indoor units can be turned ON/OFF when the security system is activated/deactivated.

Icon display (lights)



• System structure

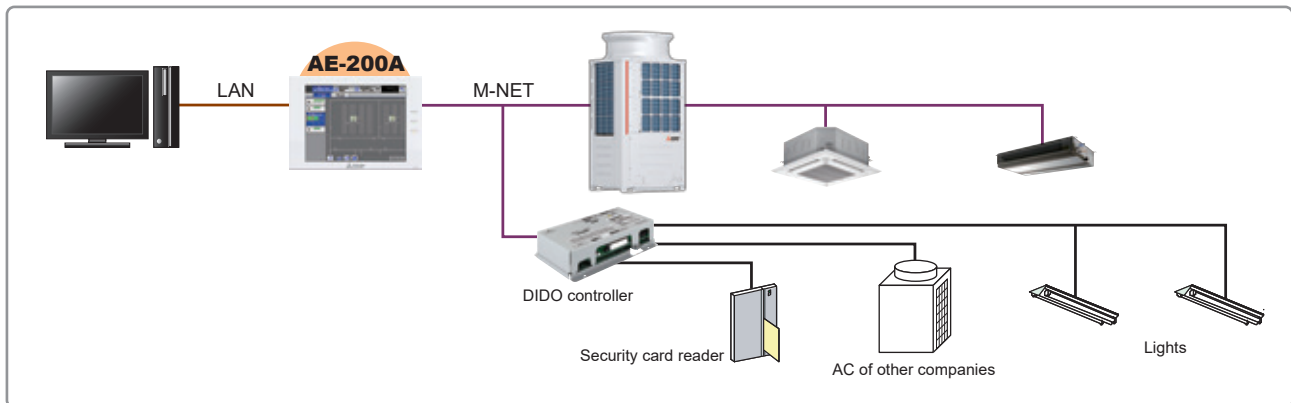

AI Controller



PAC-YG63MCA

Dimensions: 7-7/8(W) x 4-3/4(H) x 1-13/16(D) in.
: 200(W) x 120(H) x 45(D) mm

The AI controller measures temperature and humidity; it also has an alarm capability if the measurement data exceeds defined setpoints. Measurement data history can be displayed only via the AE-200A/AE-50A/EW-50A web browser. Temperature and humidity can be displayed on the AE-200A/AE-50A LCD. Furthermore, an alarm can be output if measurement data exceeds a preset upper or lower limit. The AI controller also features a function that interlocks M-NET devices for indoor units, etc.

Temperature/humidity monitoring

Monitors the values measured by the temperature/humidity sensor connected to the AI controller

Temperature: Pt100, 4 to 20 mA DC, 1 to 5 VDC, 0 to 10 VDC
Humidity: 4 to 20 mA DC, 1 to 5 VDC, 0 to 10 VDC

- Measurement data trends can be displayed on a web browser.
- An alarm can be output by e-mail when measurement data exceeds a preset upper or lower limit.

• System structure

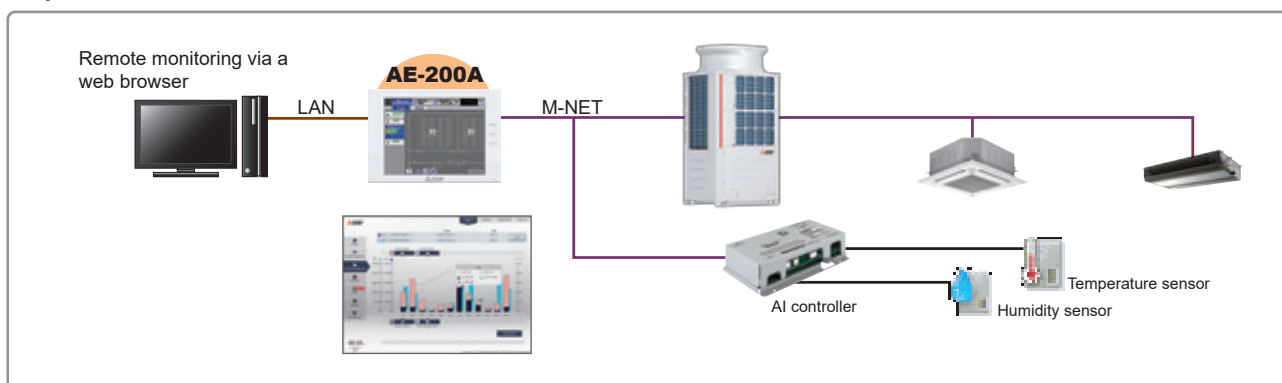

Cloud System Connection Device



MCC-50A

Dimensions: 6-13/16(W) × 8-4/16(H) × 3-15/16(D) in.

: 172(W) × 209(H) × 100(D) mm

*6-13/16 × 10 × 3-15/16 in. (172 × 253 × 100 mm) when using L-fittings

MCC is an interface between M-NET products and cloud service, allowing remote access for operation, monitoring, and service & maintenance.

• System structure

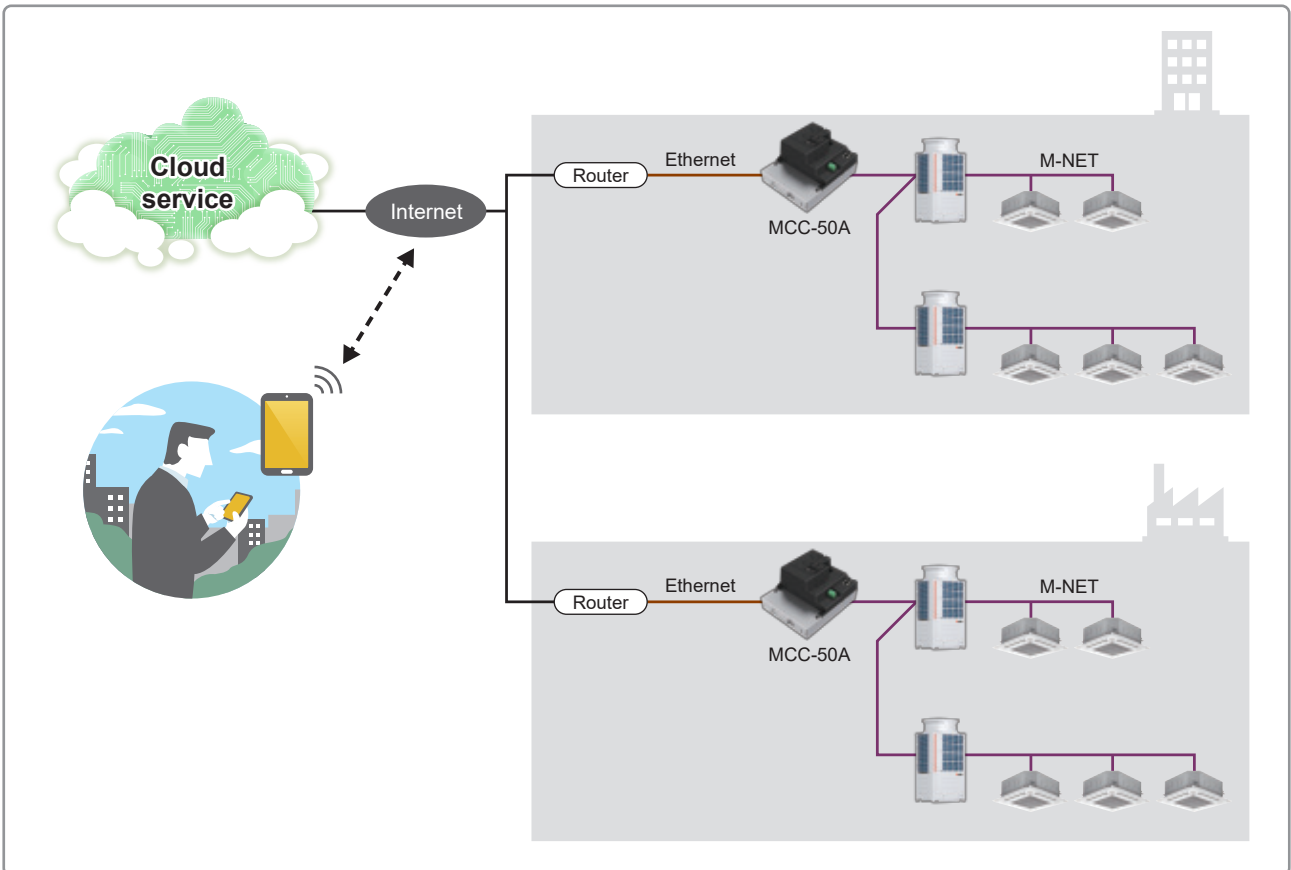

*An Internet connection is required.
Depending on the network environment, communication costs may be incurred.
Ensure sufficient network security.

*This device is not suitable for use in locations where children are likely to be present.

*Up to 50 CITY MULTI indoor units can be connected to each MCC-50A.

Cloud service

*The cloud service start date is to be determined.
Consult your distributor for detail.

BACnet®

CITY MULTI can be easily combined with a Building Management System (BMS) via the EW-50A (AE-200A). BACnet® is an open transmission protocol widely used in BMS and related equipment control. CITY MULTI is compatible with large-scale BMS management via BACnet®.



EW-50A (AE-200A) can control up to 50 units/groups (including Lossnay).

*To use the BACnet® function with the EW-50A (AE-200A), BACnet® license registration is required.

• System example

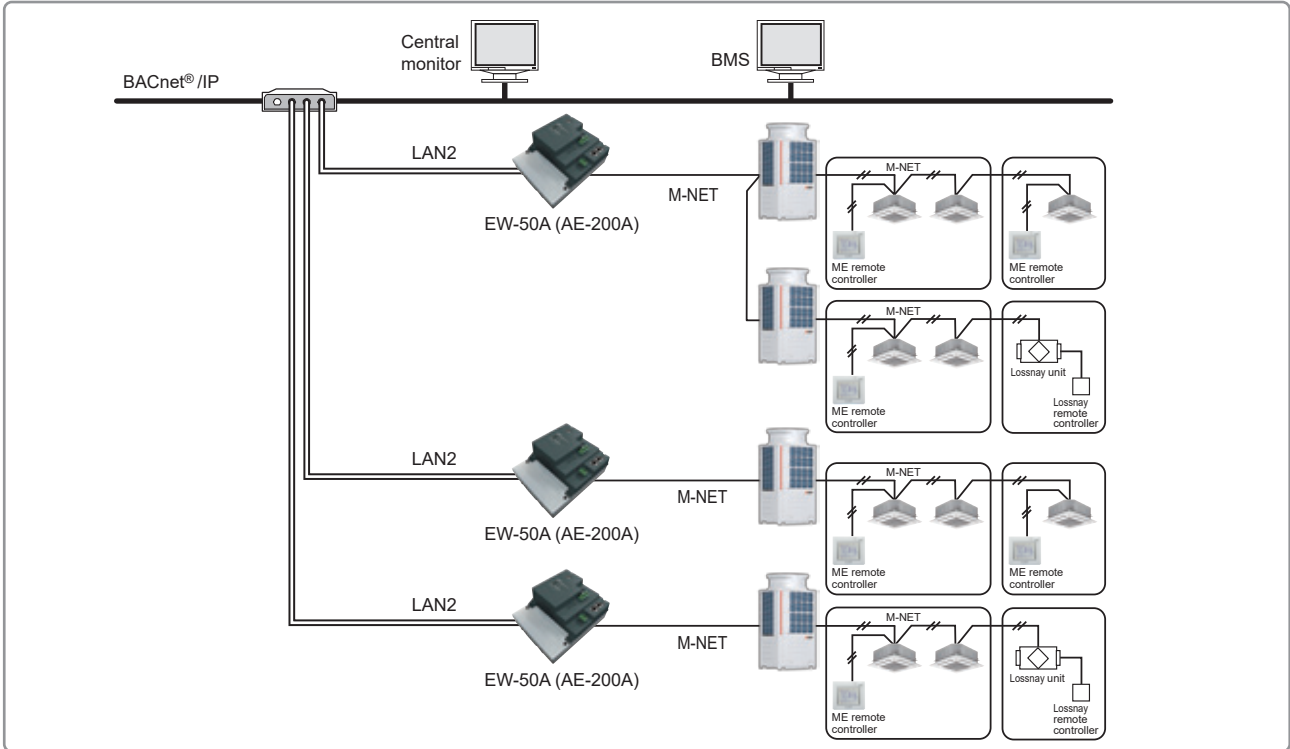

• BACnet® and M-NET adapter

FUNCTION	CONTENT
Operation	
ON/OFF	ON/OFF
Mode	Cool/Dry/Heat/Auto/Fan/Setback
Fan Speed	Low-Mid2-Mid1-High-Auto
Air Direction	Horizontal-60%-80%-100%swing
Set Temperature	Changes the set temperature. * Set temperature range varies depending on the indoor unit model.
Filter Sign Reset	Normal/Reset
Permit/Prohibit	ON/OFF, Mode, Filter sign reset, Set temp, Fan speed
Forced Off	Reset/Execute
Ventilation Mode	Heat Recovery/Bypass/Auto
Air to Water Mode	Heating/Heating ECO/Hot Water/Anti-freeze/Cooling

FUNCTION	CONTENT
Monitoring	
ON/OFF	ON/OFF
Mode	Cool/Dry/Heat/Auto/Fan/Setback
Fan Speed	Low-Mid2-Mid1-High-Auto
Air Direction	Horizontal-60%-80%-100%swing
Set Temperature	Changes the set temperature. * Set temperature range varies depending on the indoor unit model.
Filter Sign	ON/OFF
Permit/Prohibit	ON/OFF, Mode, Filter sign reset, Set temp, Fan speed
Indoor Temperature	Temperature
Alarm Signal	Normal/Error
Error Code	2 Character code- Indicates all unit alarms
Error Code Detail	4 Character code- Indicates all unit alarms
Communication State	Normal/Error
Ventilation Mode	Heat Recovery/Bypass/Auto
Air to Water Mode	Heating/Heating ECO/Hot Water/Anti-freeze/Cooling
Apportioned Electric Energy	Group, Interlocked Units 0.1 kWh
PI controller Electric Energy	0.1 kWh
Apportionment Parameter	Available*
Night Purge State	ON/OFF
Thermo On/Off State	ON/OFF
External Heat Source State	ON/OFF
Trend Log	Indoor Temp, Apportioned Electric Energy, PI controller Electric Energy, Apportionment Parameter

* To use this function, the license to charge, AE-200A (not connected to the M-NET), PI controller, watt-hour meter with pulse transmitter (locally available one) are required.

Optional parts

• For CONTROL

Model	Description	Model	Description
PAC-SE42TS-E <small>NEW</small>	Remote Sensor for A/J/K/M-Net Control	PAC-YG82TB-J	Mounting attachment for AE-200A wall-mount installations
PAC-SE55RA-E	Remote ON/OFF adapter for Indoor Unit	PAC-YG84UTB-J	Electrical box for AE-200A wall-embed installations
PAC-SA88HA-EP	Multiple Remote Controller Adapter	PAC-YG86TK-J	Mounting kit for AE-200A wall-mount installations
PAC-SC37SA-E	Output signal connector	PAC-YG72CWL-J	Surface cover with USB port for AE-200A
PAC-SC36NA-E	Input signal connector		
PAC-SF46EPA-G	Transmission booster		
PAC-YG10HA-E	External input/output adapter for AE-200A		